

Connecting Systems

for modern furniture and architectural millwork

Connecting Your Ideas...



KNAPP[®]
connectors.com



Welcome to the World of KNAPP®!

As a manufacturer of patented connecting systems, we develop and produce high-quality products that are distributed worldwide. Our connecting systems convince and inspire you with the wide range of applications. Our comprehensive service helps you find the best, most efficient and innovative solution for the realization of your projects. On the following pages, you will find our connection systems for modern furniture and architectural millwork as well as light timber construction.

Friedrich Knapp
CEO

Our Customer Service

The KNAPP®-Team provides competent advice and excellent service for your projects.

In Germany and Austria we offer full-coverage service by representatives on-site. You will find the right contact person easily and quickly.

 www.knapp-connectors.com

We offer full coverage customer service and technical support, Monday – Thursday 8 a.m. to 4.30 p.m. and Friday 8 a.m. to 12 p.m. Central European Time. Find your nearest representative today.

You can reach our office +43 (0)7474 / 799 10 or E-Mail : info@knapp-connectors.com www.knapp-connectors.com/contacts

KNAPP® Online-Store | Order around the clock

Our online store gives you the flexibility to order at any time. After a quick registration, you can immediately place your order. Finding the most fitting connecting system for your application is only a mouse click away!

 www.knapp-connectors.com/online-store



24/7
▶▶ online-store

www.knapp-connectors.com



Inform yourself



Register



Select



Order



KNAPP® offers unique connecting systems for different industries, such as:

Timber Frame Construction | Mass Timber Construction | Wood Curtain Walls | Off-site, Prefab, Modular Construction
Door and Window manufacturing | Furniture and Architectural Millwork | Structural Glazing for Timber and Metal facades



More information

www.knapp-connectors.com/downloads

Table of Contents

Biscuit Slide-in Connectors		SUNNY	4
		SILVER	4
		CHAMP	5
		CHICO	5
		METAL	6
Biscuit Clip-in and Joint Connectors		FAST	6
		CLIPS	7
		KOMBI	7
			
Panel / Hook-in Connectors		DUO 30 mL/30 oL	8
		DUO 35 mL/35 oL	8
		Locking clip	9
		UNO 30	9
Dowel Connectors		TUCK	10
		Miller® Dowel	10
		KNAPP®-DOWEL	11
		QUICK-SET	12
		ZIPBOLT™ Fastfit	12
Dovetail Snap-in Connectors		KLICK	13
		sKLICK	13
		KLICKpro	14
		miniKLICK	14
		Accessories	15
Cabinet and Case Goods Connectors		MODULAR	16
		Shoulder head screw	16
		MODULAR Anti-Rotation	17
		CONTRA 800	18
Frames, Table and Bed Rail Connectors		DUO System	19
		DUO Series	20-21
		ACRO-System	22-23
		BASIS-System	24
		RICON® Stainless Steel	25-26
Countertop Connectors		easy-con®	27
		ZIPBOLT™ 90 KD ZIPBOLT™ 85	28
		ZIPBOLT™ 120	29
		ZIPBOLT™ 170	29
		ZIPBOLT™ 100 MINI	30
Stair Tread Connectors		TREPP0	30
			
			
			
One-Component Adhesives		KNAPP®-ADHESIVE PU+	31
		KNAPP®-ADHESIVE PM+	31
			
			

SUNNY

Sliding biscuit connector, plastic

Art.-No. K053

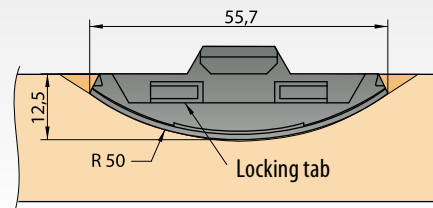
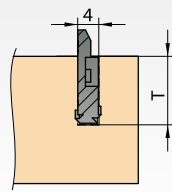

Application: Case goods, furniture, architectural millwork, shop fitting, clamping device for miter joints and corners.

Benefits: Concealed, self-tightening biscuit connector with integrated locking tabs.

Suitable materials: All softwoods and board materials without laminate surfaces.

Installation: Cut slot with biscuit joiner (#20) according to groove depth T. Knock-in both connector halves opposite of one another, following the radius of the biscuit cut using hammer and insertion tool.

Accessories: Insert tool | Art.-No. K049/E
see page 15



1) Cut #20 biscuit slot



2) Insert



3) Knock in with the insert tool



4) Assemble

SILVER

Slide-in biscuit connector, alloy-diecast

Art.-No. K049

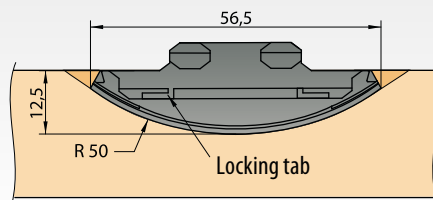
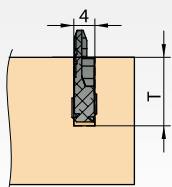

Application: Case goods, furniture, architectural millwork, shop fitting, clamping device for miter joints and corners.

Benefits: Concealed, self-tightening, demountable connector with optional integrated locking tabs.

Suitable materials: All softwood board materials.

Installation: Cut slot with biscuit joiner (#20) according to groove depth.

Accessories: Insert tool | Art.-No. K049/E
see page 15



1) Cut #20 biscuit slot



2) Engage locking tabs (optional)



3) Insert, knock in



4) Knock in with the insert tool



5) Assemble

CHAMP

Slide-in biscuit connector, glass fiber reinforced plastic

Art.-No. K023

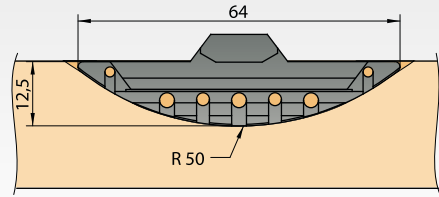
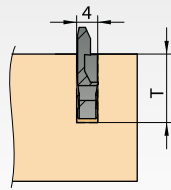

Tip: Moisten surface before gluing if wood is very dry.

Application: Case goods, furniture, architectural millwork, shop fitting, clamping device for miter joints and corners..

Benefits: Concealed, self-tightening, demountable.

Suitable materials: All wood and board materials.

Installation: Cut slot with biscuit joiner (#20) according to groove depth T. Apply KNAPP®-ADHESIVE PU+ into slot and insert connector halves.

Accessories: KNAPP®-ADHESIVE PU+ | Art.-No. Z011
see page 31



1) Cut #20 biscuit slot



2) Glue using KNAPP®-ADHESIVE PU+



3) Insert



4) Position with template



5) Assemble

CHICO

Slide connector, alloy-diecast

Art.-No. K030

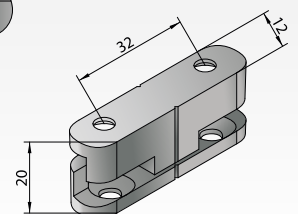
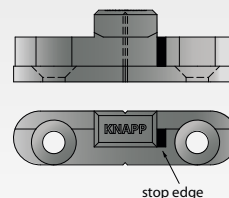
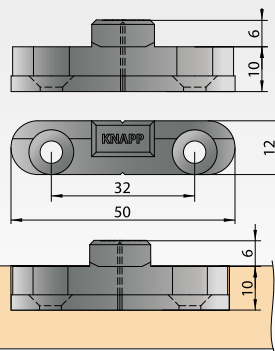

Application: Heavy furniture, case goods, panels

Benefits: Concealed, self tightening, demountable with integrated stop.

Suitable materials: All wood and board materials.

Installation: Cut mortise with plunge router or CNC machine and mount with CS-screws $\varnothing = 4,5$ mm.

Mounting: Screw in with CS-screws $\varnothing = 4,5$ mm.



1) Route mortise



2) Insert



3) Screw in



4) Assemble

METAL

Slide-in biscuit connector, alloy-diecast

Art.-No. K026

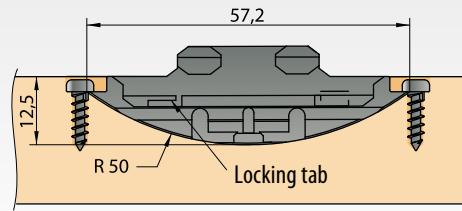
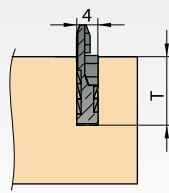

Application:	Case goods, furniture, architectural millwork, shop fitting, door frames.
Benefits:	Concealed, self-tightening, demountable connector with optional integrated locking clips.
Suitable materials:	All wood and board materials.
Installation:	Cut slot with biscuit joiner (#20) according to groove depth T. Insert both connector halves into the biscuit cuts and mount by means of PH-screws.
Mounting:	Screw in with PH-screws.
Accessories: see page 15	PH-screw 3x13 mm Art.-No. Z600 PH-screw 3x25 mm Art.-No. Z601



1) Cut #20 biscuit slot



2) Engage locking tabs (optional)



3) Screw in



4) Assemble

FAST

Clip-in biscuit connector, plastic

Art.-No. K058

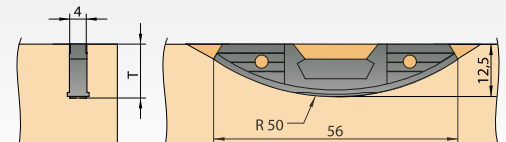
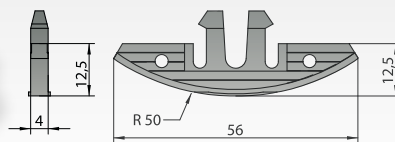

Application:	Case goods, furniture, architectural millwork, face frames, door and window casing, clamping device for miter joints and corners.
Benefits:	Concealed, self-tightening, demountable connector, immediately load bearing.
Suitable materials:	All softwoods and board materials without laminated surfaces.
Installation:	Cut slot with biscuit joiner (#20) according to groove depth T. Knock-in both connector halves following the radius of the biscuit cut using hammer and insertion tool. Optionally, KNAPP®-ADHESIVE PU+ may be used prior to insertion for a stronger hold.
Accessories: see page 15	Insert tool Art.-No. K049/E



1) Cut #20 biscuit slot



2) Insert



3) Knock-in with insertion tool



4) Assemble

CLIPS

Clip-in biscuit connector, plastic

Art.-No. K054

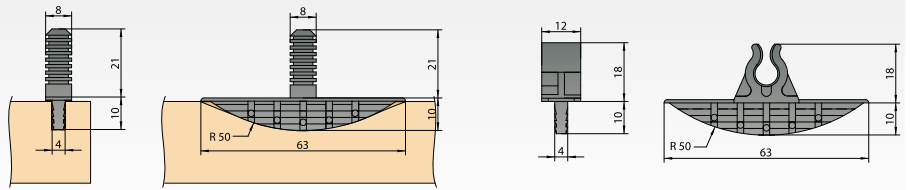

Tip: Moisten surface before gluing if wood is very dry.

Application: Cabinets, case goods, removable panels, toe kicks, miter joints, shop fittings.

Benefits: Self-tightening, demountable connector, adjustable (with or without gap).

Suitable materials: All wood and board materials.

Installation: Cut slot with biscuit joiner (#10).
Apply KNAPP®-ADHESIVE PU+ into biscuit cut and insert connector halves.

Accessories: KNAPP®-ADHESIVE PU+ | Art.-No. Z011
see page 31



1) #20 biscuit slot



2) Glue



3) Insert



4) Assemble

KOMBI

KOMBI – biscuit connector, alu/zinc diecast

Art.-No. K614

Art.-No. K615

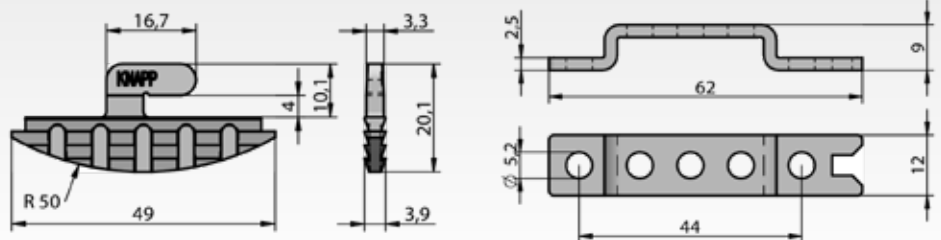

Application: Exhibition, architectural millwork, wall/facade paneling and cladding.

Benefits: Concealed, self-tightening biscuit connector

Suitable materials: All wood and board materials

Installation: Cut slot with biscuit joiner (#10) adjusting depth to 10 mm.
install with PH-screws $\varnothing=3 \times 25$ mm or glue with KNAPP-ADHESIVE PU+.

Accessories: PH-screw 3x25mm | Art.-No. Z601, CS stainless steel screw A2 4,5x35 mm | Art.-No. Z409, KNAPP® Adhesive PU+ (p. 31) | Art.-No. Z011
see page 15



1) Positioning



2) Mount KOMBI bracket with screws



3) Simply hook in the components



4) Can be detached if needed

DUO 30, DUO 35

Panel / Hook-in Connectors made of steel

Benefits:

- | Easy to mount, concealed and immediately load bearing
- | Shallow drilling depth – only 3 mm
- | Available in $\varnothing = 30$ and 35 mm
- | Optionally mL / oL (with / without sideways tolerance)
- | Installed with standard CS-screws or EURO-screws
- | Latch the connection with optional locking clip

DUO 30 mL

Art.-No. K070

CS-screws 3,5x16 mm
(not included)

DUO 30 oL

Art.-No. K074



Installation example:
Mounting on wood door leaf.

DUO 35 mL

Art.-No. K061



DUO 35 oL

Art.-No. K062

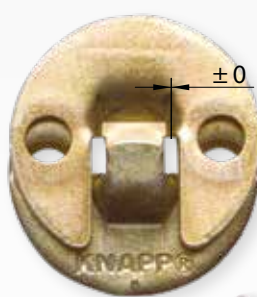

Installation example:
Mounting handrail

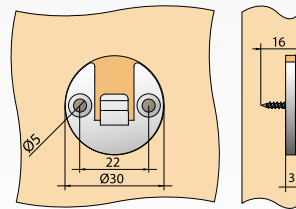
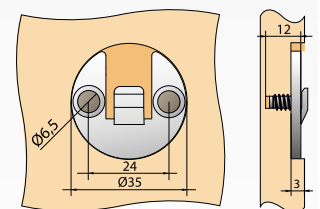
Hooking way 15 mm
Drilling depth 3 mmHooking way 15 mm
Drilling depth 3 mm

Optimized for CNC-processing:
Euro-screws 6x10 mm

**More information:**
www.knapp-connectors.com/products
Application:

Facades and windows, staircases and handrails, cabinet end panels, door and window casing.

Benefits:

Concealed, self-tightening, demountable connector which allows shrinkage and expansion moving (mL = with tolerances) or for exact placing (oL = with no tolerances).

Installation:

Drill 3mm deep holes using the KNAPP® Forstner Bit $\varnothing = 30/35$ mm using drilling jig or with CNC equipment. Mount DUO 30 with (suggested) CS-screws 3,5x16 mm / DUO 35 with (suggested) Euro-screws 6x10 mm. Screws length depends on application.

Suitable materials:

All kinds of wood and particle boards.

Accessories:

see page 15

KNAPP® Forstner Bit ($\varnothing = 30/35$ mm, adjustable depth gauge) | Art.-No. Z070 / Art.-No. Z071
Center punch DUO 30/35 | Art.-No. K071 / Art.-No. K069, Handrail punch DUO 30 | Art.-No. K075
Adjustable boring template DUO 30/35 | Art.-No. K563

Installation DUO 30



1a) Drill with jig



1b) or according to mark



2) Mark counter part with center punch



3) Install with screws

Locking clip

Optional spring steel locking clip for DUO 30 and UNO 30

Art.-No. K121

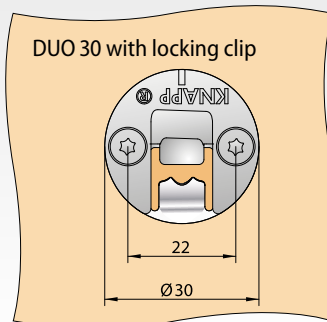
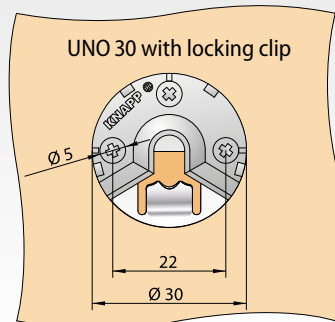

DUO 30 with locking clip

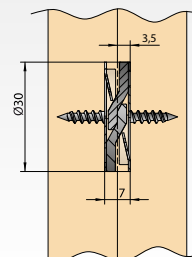

Mounting: Insert beneath DUO 30 or UNO 30 bracket prior to mounting with screws.

Benefits: Locking clip holds up to 24 kg (failure load approx. 73 kg).

UNO 30

Stainless steel hook connector with optional locking clip

Art.-No. K120 UNO 30 Set

Art.-No. K120/B UNO 30



PH-screw A2 3x13 mm
CS-holding screw A2 5x50 mm

Additional screw lengths available upon request.

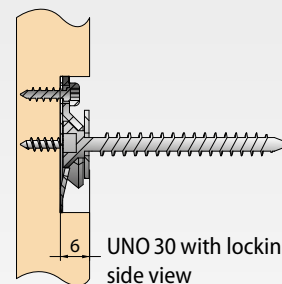

UNO 30 with locking clip, side view

Application: Paneling, facades, handrails, furniture (use with or without locking clip).

Benefits: Concealed, self tightening, demountable connector for 30 mm drills.

Installation: Drill a 7mm deep hole using the KNAPP Forstner Bit Ø = 30 mm using center punch and drilling jig or with CNC equipment.

Suitable materials: All wood materials including concrete and drywall with use of wall anchor.

Accessories: KNAPP® Forstner Bit (Ø = 30 mm, with adjustable depth stop) | Art.-No. Z070
Center punch UNO 30 | Art.-No. K073
Adjustable boring template UNO 30 | Art.-No. K563, Locking clip | Art.-No. K121



1a) Drilling with jig



1b) or according to mark



2) Mount with screws



3) Transfer mark with center punch



4) Attach holding screw

TUCK

Dowel, spring steel

Art.-No. Z5052	Art.-No. Z5053	Art.-No. Z5055	Art.-No. Z5055B	Art.-No. Z5052A
6x25 mm	8x35 mm	10x32 mm	10x16 mm	10x28 mm

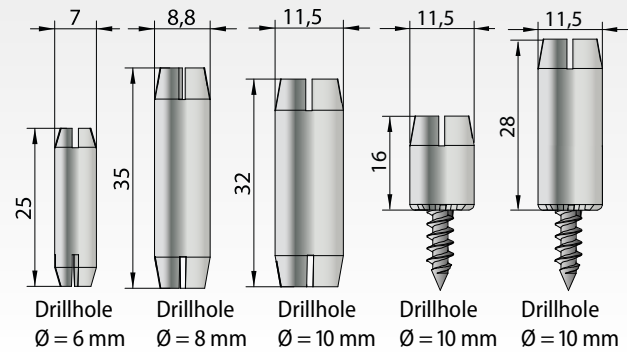

Application: Cabinets, case goods, architectural millwork, shop fitting. Anywhere standard wood dowels are used.

Suitable materials: All kind of wood materials (solid and composite).

Benefits: Concealed, self-tightening compression dowel, immediately load bearing.

Installation: Dowel drilling jig, Doweling joiner, CNC drilling. Insert or screw on the TUCK.



1a) Drill with doweling machine



1b) or doweling joiner



2a) Knock in



2b) or screw



3) Attach holding screw

MILLER DOWEL

The wooden dowel for decorative joints

Art.-No. check our online-store

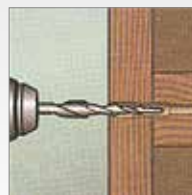

1) Drill

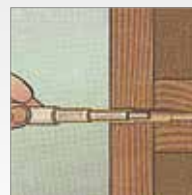

2) Apply wood glue and position

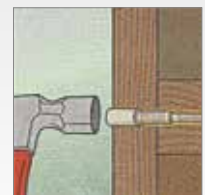

3) Knock in

Application: For connecting ecologically decorative furniture

Benefits: Easy installation, ecological and sustainable, decorative design

Installation: Drill with custom stepped drill bit, apply adhesive in borehole and insert dowel.

Suitable materials: Solid wood, plywood, high gloss-MDF

Accessories: MILLER® TruFit Drill Bit | Art.-No. Z01D, Z02D, Z03D (check online-store).



Available in: Birch, Oak, American nut and Cherry woods.



Frame connections



Case goods



Load bearing connection

KNAPP®-DOWEL

Plastic dowel

Benefits:

- Effective prefabrication – doweling jig or automatic doweling machine
- Fast installation – connection can be used immediately after insertion
- Design - channel along dowel allows for smooth distribution of adhesive and prevents surface from bulging
- No shrinking or swelling will occur, thus no risk of breaking or splitting as with wooden dowels
- Weather resistant – high quality polyacetal (POM) plastic for interior and exterior use
- Strong hold – through additional bonding with KNAPP®-ADHESIVE PU+

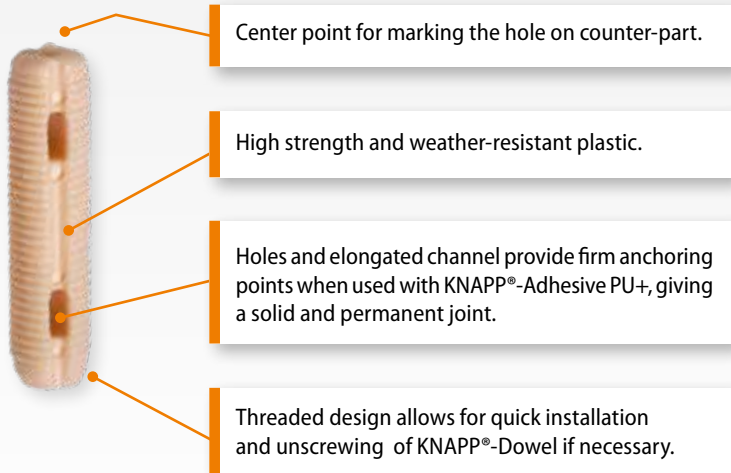

KNAPP®-DOWEL 6 mm

Art.-No. K066
6x28 mm

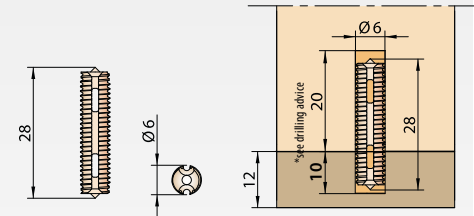

Info: Moisten the surface of very dry wood before gluing.

KNAPP®-DOWEL 8 mm

Art.-No. K067
8x36 mm

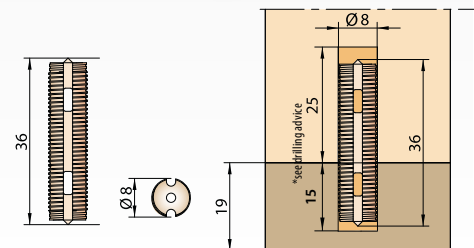

 More information:
www.knapp-connectors.com/dowel

Application:	Case goods, furniture, architectural millwork and shop fitting, windows. Wherever wood dowels can be used.
Benefits:	UV-resistant, self-tightening dowel.
Installation:	Drill holes with doweling jig or doweling joiner. Insert by hand with hammer or automated dowel insertion machine. Optionally, insert adhesive before inserting dowel.
Suitable materials:	All kinds of wood materials (solid and composite).
Accessories:	KNAPP®-ADHESIVE PU+ Art.-No. Z011 see page 31

KNAPP®-DOWEL

Installation



1a) Drill with doweling machine



1b) or doweling joiner



2) Glue with KNAPP®-Adhesive PU+



3) Knock in



4) Assemble

 For instruction manuals, .DXF drawings for KNAPP®-DOWEL as well as your personal consultant in your area, please visit:
www.knapp-connectors.com/downloads

QUICK-SET

2-part Locking Dowel

Art.-No. Z5056	Art.-No. Z5058	Art.-No. Z5057	Art.-No. Z5059
5 mm bolt	5 mm bolt	8 mm bolt	8 mm bolt

Drilling depth 31-32 mm



Threaded stud for Ø 5 mm hole Threaded stud for Ø 5 mm hole Threaded stud for Ø 8 mm hole Threaded stud for Ø 8 mm hole Plastic sleeve for Ø 8 mm hole

Application:	Furniture, architectural millwork, shop fitting. Wherever wooden dowels are used.
Benefits:	Concealed, self-tightening, no glue necessary.
Installation:	Drill holes with doweling jig or doweling joiner and insert by screwing in threaded stud. Insert plastic sleeve on counter part and insert threaded stud into plastic sleeve.
Suitable materials:	All kind of wood boards (solid and composite).



- 1a) Drill with doweling machine 1b) or doweling joiner 2) Screw-in metal stud 3) Insert plastic sleeve 4) Assemble

Zipbolt™ Fastfit

One-piece nesting connector for material ≥ 16 mm

Art.-No. Z339



One piece joint connector

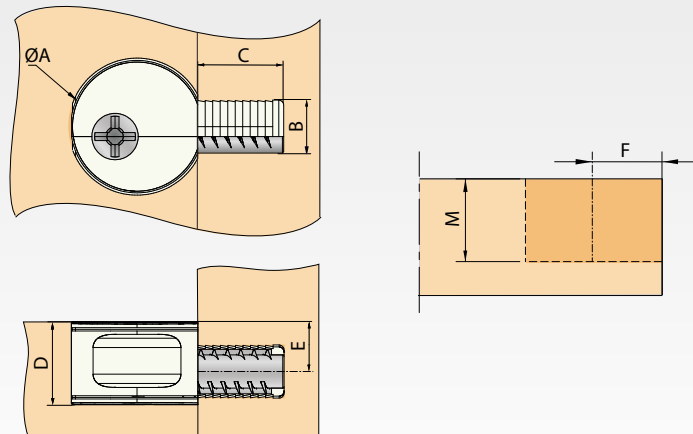

Drilling depth M	Ø A	B	C	D	E	F
13 mm	20 mm	8 mm	12,5 mm	12,5 mm	7,5 mm	min. 9,5 mm

Application:	Cabinets, case goods, architectural millwork and shop fitting.
Benefits:	One-piece nesting connector.
Installation:	Drill dowel hole with drilling hand held machine or CNC. Insert into 20 mm nest hole and insert into drill holes of counter part. Tighten components with #2 Phillips screw driver.

Suitable materials: Wood panels, composite materials.



KLICK

Dovetail snap-in connector, plastic

Art.-No. K045

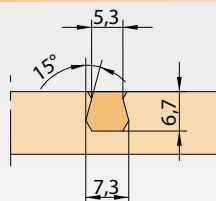
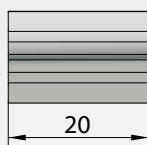
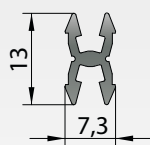

Application: Concealed mounting of moldings, trims and mitered corners as well as gluing aid.

Benefits: Concealed, self-tightening, demountable.

Installation: Use a router table or CNC to make dovetail route and snap KLICK into route. Can also be used in combination with KLICKpro.

Suitable materials: For all solid wood, wood based panels and plastic materials.

Accessories: KLICK Dovetail Router Bit with $\varnothing = 8$ mm shank | Art.-No. K046/F, $\varnothing = 6$ mm shank | Art.-No. K045/F; $\varnothing = 6,35$ mm/1/4" shank | Art.-No. K048/F, $\varnothing = 12,7$ mm/1/2" shank | Art.-No. K047/F. see page 15

Installation



Dovetail Router Bit with $\varnothing 8$ mm shaft Art.-Nr. K046/F



1) Route groove

2) Insert

3) Position

4) Snap-in

sKLICK

Dovetail snap-in connector for screw mounting, plastic

Art.-No. K048

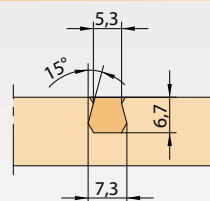
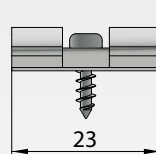
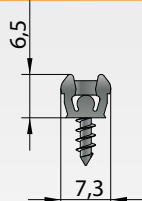

Application: For concealed mounting of filler panels, covers and moldings.

Benefits: Self-tightening, demountable connector for any angles 0-90°.

Installation: Attach with PH-screw 3x13 | Art.-No. Z600, and snap sKLICK into the route. Can also be used in combination with KLICKpro.

Suitable materials: For all solid wood, wood based panels and plastic materials.

Accessories: KLICK Dovetail Router Bit with $\varnothing = 8$ mm shank | Art.-No. K046/F, $\varnothing = 6$ mm shank | Art.-No. K045/F; $\varnothing = 6,35$ mm/1/4" shank | Art.-No. K048/F, $\varnothing = 12,7$ mm/1/2" shank | Art.-No. K047/F. see page 15

Installation



1) Route groove

2) Mount with screw

3) Position

4) Snap-in

KLICKpro

Dovetail receiving connector for KLICK and sKLICK, plastic

Art.-No. K060

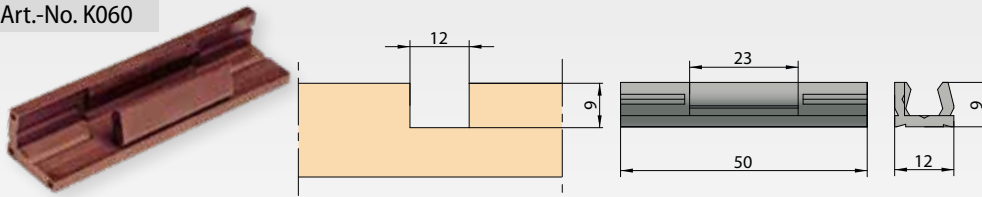

Application: For concealed mounting of filler panels, covers and moldings.

Benefits: Concealed, self-tightening dovetail housing suitable for KLICK and sKLICK.

Installation: Cut either groove or rebate (9x12 mm by using a spindle moulder or CNC) or install KLICKpro surface mounted. For use with KLICK or sKLICK. Fixed KLICKpro by either screwing, nailing or gluing.

Suitable materials: For all solid wood, wood based panels and plastic materials.



Solarlux (DE)

Installation



1) Route groove



2) Mount with screws



3) Snap together



Combination with KLICKpro

miniKLICK

2-part dovetail snap-in connector, plastic

Art.-No. K059

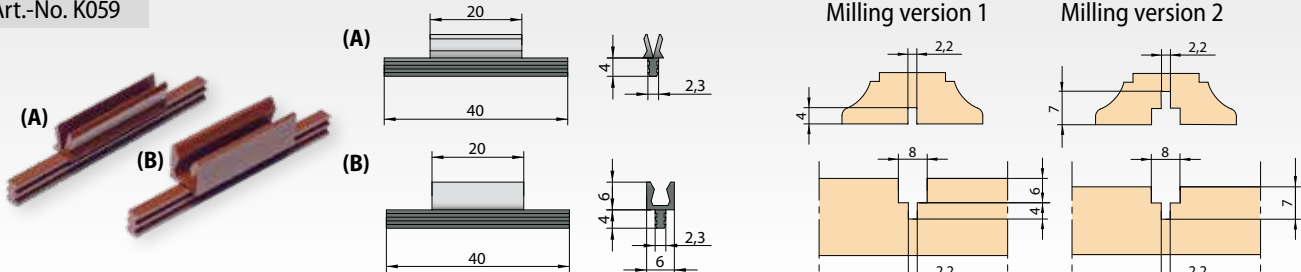

Application: For concealed mounting of small moldings and glazing beads e.g. interior doors.

Benefits: Concealed, self-tightening dovetail connector.

Installation: Make groove with spindle moulder and cutting saw blade. Apply KNAPP-ADHESIVE PU+ glue into groove.

Suitable materials: For all solid wood, wood based panels and plastic materials.

Accessories: miniKLICK grooving saw blade 120 mm, $\varnothing = 30$ mm drillhole | Art.-No. Z065 (See page 15).
Insert tool miniKLICK | Art.-No. K068
KNAPP®-ADHESIVE PU+ | Art.-No. Z011 (See page 31)



Installation



1) Route groove



2) Insert



3) Snap together



Option: Glue with KNAPP®-Adhesive PU+



Accessories

Insert tool

Art.-No. K049/E To position SUNNY, SILVER, and FAST.



Center punch DUO 30/35

Art.-No. K071 Center punch DUO 30.

Art.-No. K075 Handrail punch DUO 30.

Art.-No. K069 Center punch DUO 35 with $\varnothing = 5$ mm for pre-drilling holes for Euro-screws.

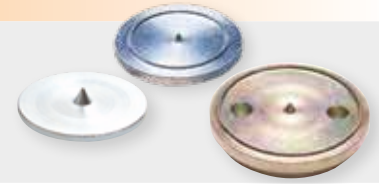

KNAPP® Forstner Bit $\varnothing = 30$ mm / 35 mm

Art.-No. Z070 KNAPP® Forstner Bit for DUO 30 and UNO 30 ($\varnothing = 30$ mm) with adjustable depth stop.

Art.-No. Z072 KNAPP® Forstner Bit for DUO 30 and UNO 30 ($\varnothing = 30$ mm) with adjustable depth stop and adjustable centering point.

Art.-No. Z071 KNAPP® Forstner Bit for DUO 35 ($\varnothing = 35$ mm) with adjustable depth stop.

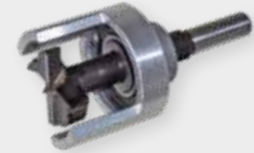

Adjustable drilling jig

Art.-No. K563 Drilling jig suitable for KNAPP® Forstner Bit 30 and 30mm to drill holes for DUO 30, DUO 35 and UNO 30.



Center punch UNO 30

Art.-No. K073 To transfer center mark to opposing wood component when using UNO 30.



KLICK Dovetail Router Bit and 2 Flute Straight Router Bit

Art.-No. K045/F KLICK Router Bit with $\varnothing = 6$ mm shank. (To rout dovetail groove for KLICK and sKLICK)

Art.-No. K046/F KLICK Router Bit with $\varnothing = 8$ mm shank. (To rout dovetail groove for KLICK and sKLICK)

Art.-No. K048/F KLICK Router Bit with $\varnothing = 6,35$ mm shank. (To rout dovetail groove for KLICK and sKLICK)

Art.-No. Z066 2 Flute Straight Router Bit $\varnothing = 15$, Length = 25 mm with $\varnothing = 8$ mm shank (CONTRA 800, DUO-System)



miniKLICK Grooving Saw Blade

Art.-No. Z065 miniKLICK Grooving Saw Blade $\varnothing = 120$ mm, spindle $\varnothing = 30$ mm.
(For routing of the groove for miniKLICK connector).



PH-screws and CS-screws

Art.-No. Z600 PH-screw 3x13 mm (for METAL, UNO 30 and sKLICK).

Art.-No. Z601 PH-screw 3x25 mm (for METAL).

Art.-No. Z409 CS-stainless steel screw A2 4,5x35 mm (to install KOMBI)

Art.-No. Z631 PH-stainless steel screw 3x13 mm (to install sKLICK)



KNAPP® Online Store | Order around the clock



24/7
online-store



Our online store gives you the flexibility to order at any time. After a quick registration, you can immediately place your order. Finding the most fitting connecting system for your application is only a mouse click away!*

 www.knapp-connectors.com/online-store

* in Germany and Austria. Not available Switzerland, Poland and America.

MODULAR

Clip connector, spring steel with shoulder head screw

MODULAR 4031

Art.-No. Z4031



Pass-thru clip

MODULAR 4032

Art.-No. Z4032



Easy to release clip



Hard to release clip

Art.-No. Z4032C

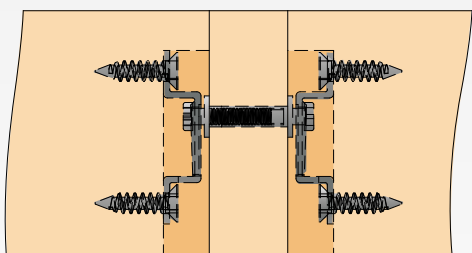
Drill and depth-jig
for connector groove

MODULAR double side connection for vertical panels

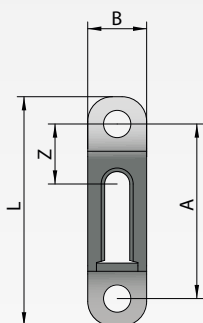

Continuous groove

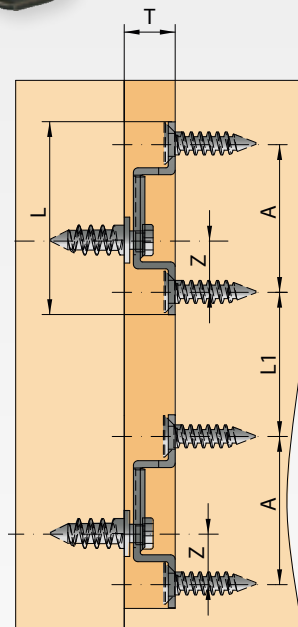
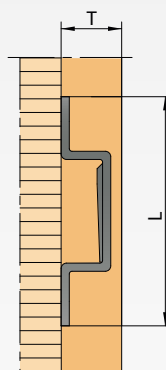

MODULAR	4031, 4032, 4035
Routing depth T:	11 mm
Routing length L:	≥ 42 mm
Routing width B:	11 mm
Center distance Z:	11 mm
Panel thickness from:	16 mm
Hole-line A:	32 mm

MODULAR clip, suitable with the 32 mm
system boring

Totally concealed installation

Application: Flat pack, RTA cabinets, case goods, and furniture.**Benefits:** Concealed, self-tightening connector for 32 mm system, demountable, for timber and steel.**Installation:** Make groove with spindle moulder, plunge router, CNC equipment.**Installation:** Pre-drill with drill-jig and install clips with PH- or CS-screws $\varnothing = 4,5$ mm (length depending on application).
Shoulder head screw engages with the clip when sliding them into each other.**Suitable materials:** For all solid wood, wood based panels and plastic materials from 16 mm thickness up.**Accessories:** Drill and depth-jig | Art.-No. Z4032C

MODULAR - shoulder head screw

Shoulder head screws

MODULAR 2055

Art.-No. Z2055



Thread length:

13 mm

MODULAR 2155

Art.-No. Z2155



16 mm

MODULAR 2055

Art.-No. Z5068



32 mm

Double side connection

Shoulder head screws M4

MODULAR 2069

Art.-No. Z2069



15 mm

MODULAR 2066

Art.-No. Z2066



16 mm

MODULAR

Anti-rotation spring steel clip with integrated stop

MODULAR 2075

Art.-No. Z2075

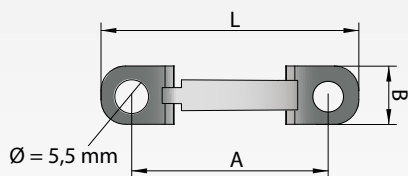

For PH- or CS-screws up to $\varnothing = 4,5$ mm

MODULAR 2076

Art.-No. Z2076

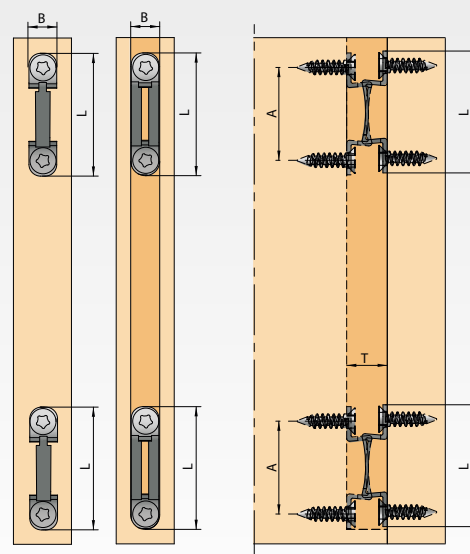
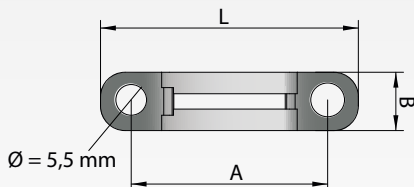

Anit-rotation Clip for case goods

MODULAR 5075

MODULAR 5071

Art.-No. Z5075

Art.-No. Z5071

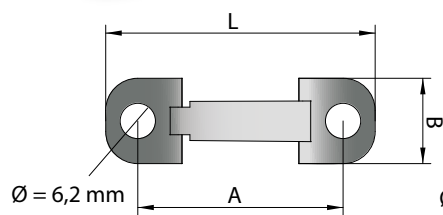

For PH- or CS-screws up to $\varnothing = 5$ mm

MODULAR 5076

MODULAR 5072

Art.-No. Z5076

Art.-No. Z5072

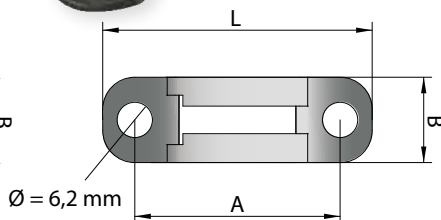

Frame joint with MODULAR anti-rotation clip.

MODULAR	2075, 2076	5075, 5076, 5075, 5076
Routing depth T:	14 mm	12 mm
Routing width B:	10 mm	13,5 mm
Routing length L:	42 mm	42 mm
Panel thickness from:	16 mm	19 mm
Hole-line A:	32 mm	32 mm

Application: Flat pack case goods and furniture.

Benefits: No rotation, concealed, self-tightening connector for 32 mm system, demountable.

Installation: Make groove with spindle moulder, horizontal router table, CNC equipment.
Pre-drill with drill-jig and install clips with PH or CS-screws $\varnothing = 4,5$ mm (length depending on application).

Suitable materials: For all solid wood, wood based panels and plastic materials from 16 mm thickness up.

Installation



1) Route groove



2) Check depth



3) Pre-drill



4) Install clip



5) Place PH-screw

CONTRA 800

Connector for case goods

Art.-No. K800/B



Screw recommendation

1 pc. EURO-screw CS 6,3x13 mm and
1 pc. EURO-screw CS 6,3x35 mm
(Depending on the requirement, different
lengths can be used)



Alternative screws

1 pc. CS-screw 4,0x16 mm and
1 pc. CS-screw 4,0x40 mm
(Depending on the requirement, different
lengths can be used)

Application details

The new screw connector CONTRA 800 is simply screwed on and can be used indoors and outdoors. Material thickness as little as 8 mm can be used when CONTRA 800 is combined with Euro screws. An ideal connector with rebate cuts. CONTRA can be used with Euro screws as little as 6 mm long.

Mounting: Screw with CS or EURO Screw.

Benefits: Fast and universal.

Processing: Only one saw cut or rout.

Material selection: All wood and plastic materials.

Furniture components / corner joints

Recessed on
end grain in 90°

or

Recessed on
face grain in 90°

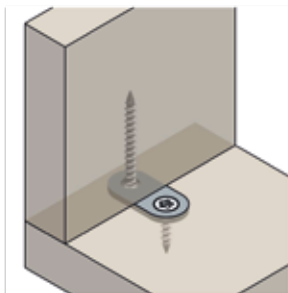
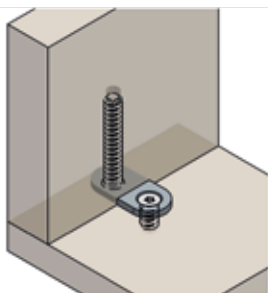

Crown molding and trim

Plinth block

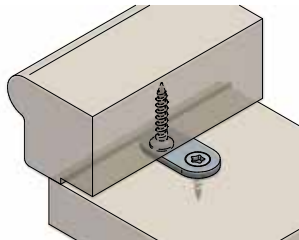

Facades, siding, and decking

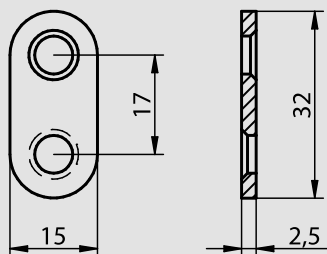

Dimensions and material:

Length: 32 mm

Width: 15 mm

Thickness: 2,5 mm

Material: Steel, blue galvanized surface

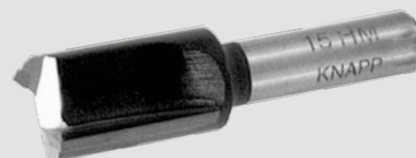

2 Flute Straight Router Bit
Art. No. Z066

DUO-System

Frame connectors



Note: Connectors consist of two identical brackets and are manufactured from high strength galvanized steel in Austria.

Application: Furniture frames, stairs, exhibition booths, and architectural millwork.

Benefits: Concealed, self-tightening, adjustable and demountable.

Installation: Make mortise with plunge router or CNC.
Install with CS-screws $\varnothing = 5$ mm or $\varnothing = 6$ mm and PH-holding screws $\varnothing = 5$ mm or $\varnothing = 6$ mm.
(screw length depending on application).

Suitable materials: All solid wood and plywood materials from ≥ 21 mm.

Accessories

Routing-jigs MULTI F (plywood)

- Routing-jig MULTI F 15, | Art.-No. K500 (for DUO 46/15, DUO 62/15, DUO 100/15)
- Routing-jig MULTI F20, | Art.-No. K506 (for DUO 90/20)
- Routing-jig MULTI F30, | Art.-No. K501 (for DUO 46/30, DUO 62/30)
- Routing-jig MULTI F46, | Art.-No. K503 (for DUO 90/46)

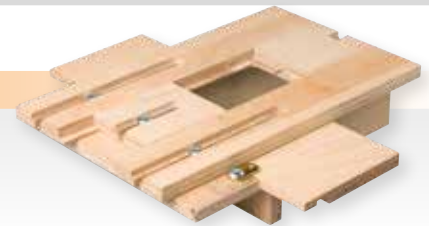

Advice: All routing-jigs are suitable for a $\varnothing = 30$ mm guide bushing (for plunge router) and a $\varnothing = 15$ mm 2 Flute Straight Router Bit.

2 Flute Straight Router Bit

$\varnothing = 15$ mm, length = 25 mm with $\varnothing = 8$ mm shank | Art.-No. Z066/08



Mounting screws (pan head screws, full threaded)

- PH-screws 5x40 (200 pcs./package) | Art.-No. Z702 (for DUO und MODULAR Anti-Rotation)
- PH-screws 5x60 (200 pcs./package) | Art.-No. Z704 (for DUO und MODULAR Anti-Rotation)
- PH-screws 6x40 (250 pcs./package) | Art.-No. Z800 (for DUO)
- PH-screws 6x60 (200 pcs./package) | Art.-No. Z802 (for DUO)



Mounting screws (countersunk screws, full threaded)

- CS-screws 5x40 (500 pcs./package) | Art.-No. Z500 (for DUO und ACRO)
- CS-screws 5x60 (250 pcs./package) | Art.-No. Z498 (for DUO, ACRO und BASIS)
- CS-screws 6x40 (250 pcs./package) | Art.-No. Z501 (for DUO und ACRO)
- CS-screws 6x60 (200 pcs./package) | Art.-No. Z499 (for DUO, ACRO und BASIS)



Installation



1) Route mortise



2) Mount with CS and PH-screws



3) Assemble

DUO 26

DUO 26/26 mm

Art.-No. K047

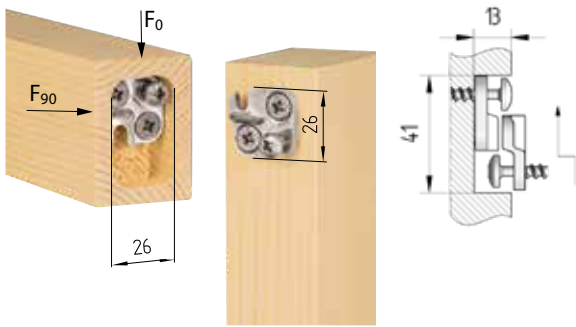

Mounting screws	5x40	5x60	Load capacity	
			zul F ₀	zul F ₉₀
PH	1	1	Slide-in direction	Right angle to slide-in direction
CS	2	2	0,97 kN	1,07 kN
Recommended timber dimension			Size of rebate	
Width/Height: 50x50 mm			Width	Height
			26 mm	41 mm
			Depth	13 mm

DUO Series 15

DUO 46/15 mm

Art.-No. K041

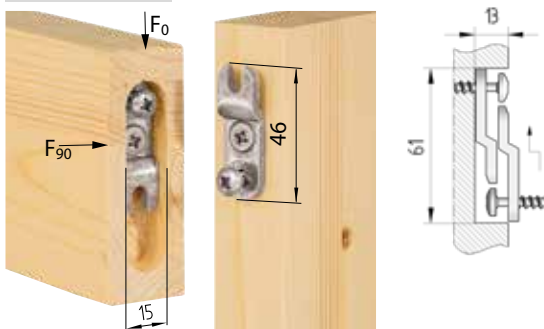

Mounting screws	5x40	5x60	Load capacity	
			zul F ₀	zul F ₉₀
PH	1	1	Slide-in direction	Right angle to slide-in direction
CS	1	1	0,86 kN	0,62 kN
Recommended timber dimension			Size of rebate	
Width/Height: 30/80 mm			Width	Height
			15 mm	61 mm
			Depth	13 mm

DUO 62/15 mm

Art.-No. K036

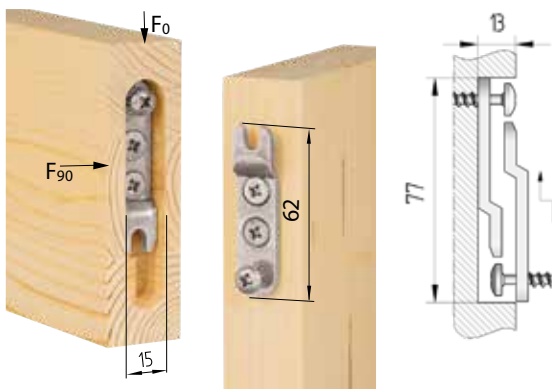

Mounting screws	5x40	5x60	Load capacity	
			zul F ₀	zul F ₉₀
PH	1	1	Slide-in direction	Right angle to slide-in direction
CS	2	2	1,29 kN	0,71 kN
Recommended timber dimension			Size of rebate	
Width/Height: 30/100 mm			Width	Height
			15 mm	77 mm
			Depth	13 mm

DUO 100/15 mm

Art.-No. K055

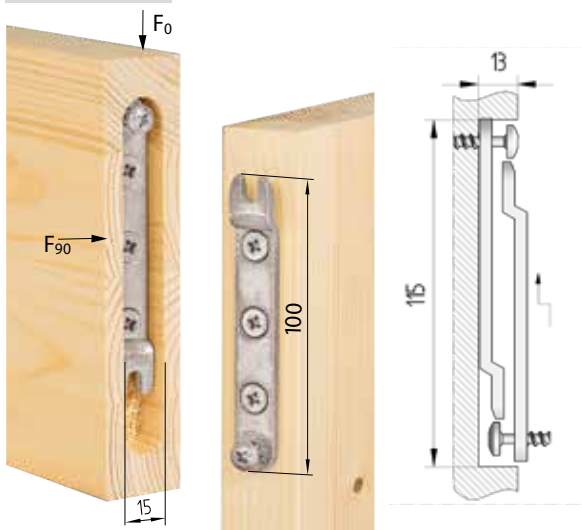

Mounting screws	5x40	5x60	Load capacity	
			zul F ₀	zul F ₉₀
PH	1	1	Slide-in direction	Right angle to slide-in direction
CS	3	3	2,00 kN	0,92 kN
Recommended timber dimension			Size of rebate	
Width/Height: 30/140 mm			Width	Height
			15 mm	115 mm
			Depth	13 mm

DUO Series 30

DUO 46/30 mm

Art.-No. K046

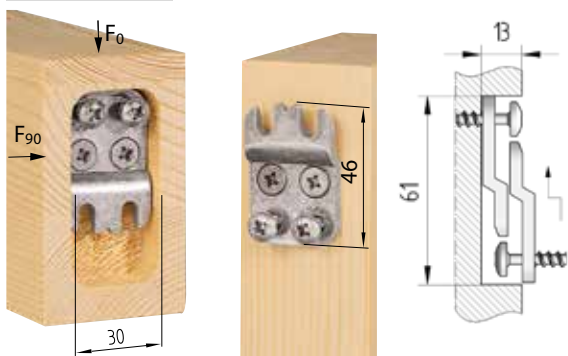

Mounting screws	5x40	5x60	Load capacity	
			zul F ₀	zul F ₉₀
PH	2	2	Slide-in direction	Right angle to slide-in direction
CS	2	2	1,30 kN	1,12 kN
Recommended timber dimension			Size of rebate	
Width/Height: 50/80 mm			Width	Height
			30 mm	61 mm
			Depth	13 mm

DUO 62/30 mm

Art.-No. K022

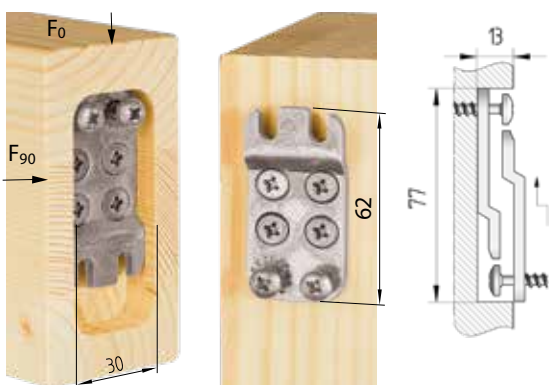

Mounting screws	5x40	5x60	Load capacity	
			zul F ₀	zul F ₉₀
PH	2	2	Slide-in direction	Right angle to slide-in direction
CS	4	4	2,15 kN	1,67 kN
Recommended timber dimension			Size of rebate	
Width/Height: 50/100 mm			Width	Height
			30 mm	77 mm
			Depth	13 mm

DUO 20 and 46

DUO 90/20 mm

Art.-No. K037

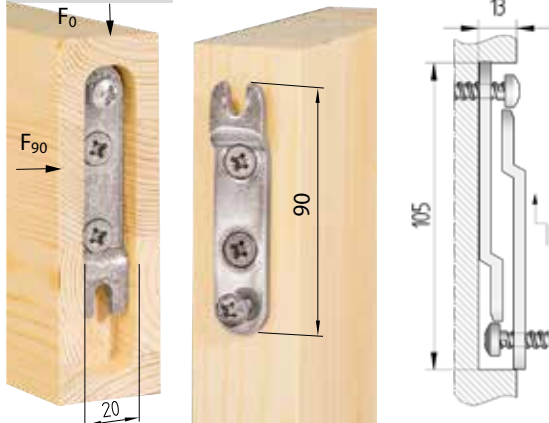

Mounting screws	6x40	6x60	Load capacity	
			zul F ₀	zul F ₉₀
PH	1	1	Slide-in direction	Right angle to slide-in direction
CS	2	2	2,37 kN	1,03 kN
Recommended timber dimension			Size of rebate	
Width/Height: 40/120 mm			Width	Height
			20 mm	105 mm
			Depth	13 mm

DUO 90/46 mm

Art.-No. K040

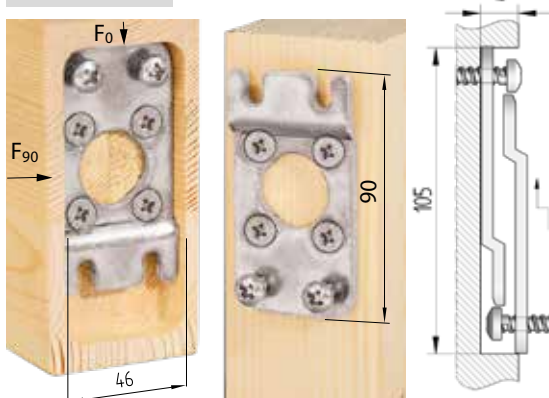

Mounting screws	6x40	6x60	Load capacity	
			zul F ₀	zul F ₉₀
PH	2	2	Slide-in direction	Right angle to slide-in direction
CS	4	4	4,35 kN	2,28 kN
Recommended timber dimension			Size of rebate	
Width/Height: 60/120 mm			Width	Height
			46 mm	105 mm
			Depth	13 mm

Acro-System

Post and beam connectors.

Application:	Post and beam joints for light timber construction.
Benefits:	Concealed, self-tightening, connector for post and beam connections.
Installation:	Mill pocket with plunge router and MULTI F routing jig. Install connector with CS-screws $\varnothing = 5$ mm or $\varnothing = 6$ mm and PH retaining screws $\varnothing = 5$ mm or $\varnothing = 6$ mm (screw length depending on application)
Suitable materials:	Solid wood material.
Accessories:	Routing Jig MULTI F, Marking template, 2 Flute Straight Router Bit (Art.No. Z066). Various CS-screw lengths available on demand.



Acro Series 47

Acro 46/47 mm

Art.-No. K042

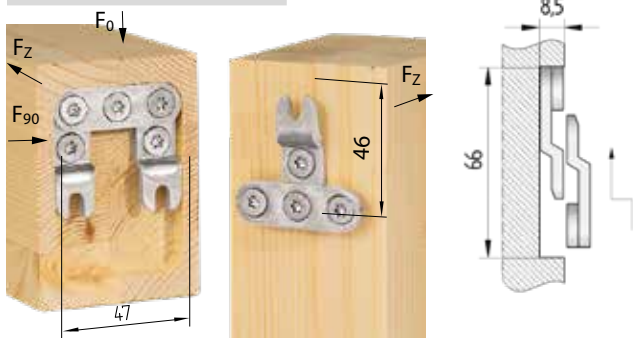

Mounting screws	5x40	5x60	Load capacity		
			zul F ₀	zul F ₉₀	zul F _Z
CS, VG	4	5	Slide-in direction	Right angle to slide-in direction	Traction
			1,43 kN	0,98 kN	1,93 kN
Recommended timber dimension			Size of rebate		
Width/Height: 55/75 mm			Width	Height	Depth
			47 mm	66 mm	8,5 mm

Acro 62/47 mm

Art.-No. K033

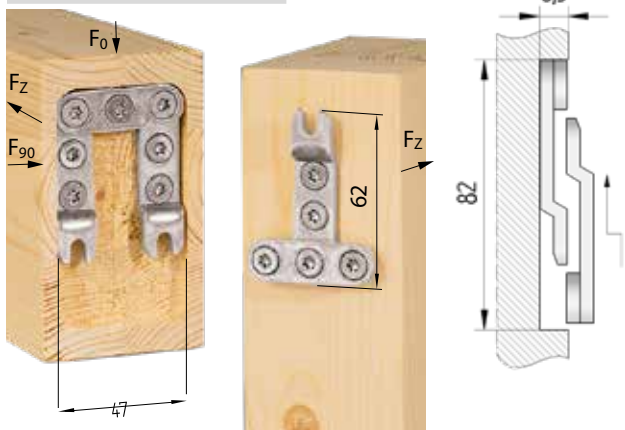

Mounting screws	5x40	5x60	Load capacity		
			zul F ₀	zul F ₉₀	zul F _Z
CS, VG	5	7	Slide-in direction	Right angle to slide-in direction	Traction
			2,47 kN	1,64 kN	1,55 kN
Recommended timber dimension			Size of rebate		
Width/Height: 60/100 mm			Width	Height	Depth
			47 mm	82 mm	8,5 mm

Acro 100/47 mm

Art.-No. K057

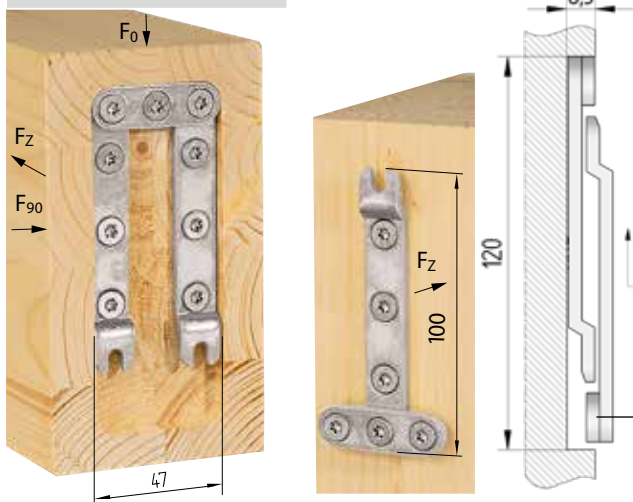

Mounting screws	5x40	5x60	Load capacity		
			zul F ₀	zul F ₉₀	zul F _Z
CS, VG	6	9	Slide-in direction	Right angle to slide-in direction	Traction
			4,14 kN	2,78 kN	1,75 kN
Recommended timber dimension			Size of rebate		
Width/Height: 75/135 mm			Width	Height	Depth
			47 mm	120 mm	8,5 mm

Note: Screw connection shall be on appropriate height adjustment

The load value refers to the shear force in the insertion direction. Commercially available CS-screws (5x40, 5x60, 6x40, 6x60 mm) in accordance with ÖNORM M 5027 must be used in ACRO systems. The test was carried out by Holzforschung Austria.

Acro Series 62

Acro 46/62 mm

Art.-No. K043

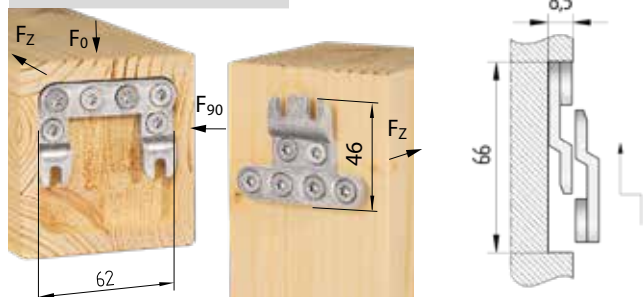

Mounting screws	5x40	5x60	Load capacity		
			zul F ₀	zul F ₉₀	zul F _Z
CS, VG	6	6	Slide-in direction	Right angle to slide-in direction	Traction
			2,11 kN	1,55 kN	
Recommended timber dimension			Size of rebate		
Width/Height: 78/78 mm			Width	Height	Depth
			62 mm	66 mm	8,5 mm

Acro 62/62 mm

Art.-No. K031

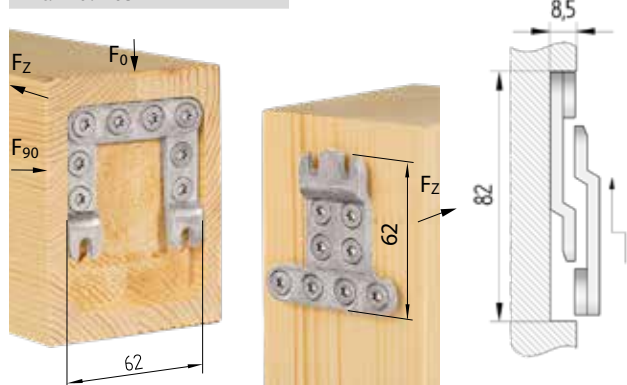

Mounting screws	5x40	5x60	Load capacity		
			zul F ₀	zul F ₉₀	zul F _Z
CS, VG	8	8	Slide-in direction	Right angle to slide-in direction	Traction
			2,53 kN	1,80 kN	
Recommended timber dimension			Size of rebate		
Width/Height: 80/100 mm			Width	Height	Depth
			62 mm	82 mm	8,5 mm

Acro 90/62 mm

Art.-No. K034

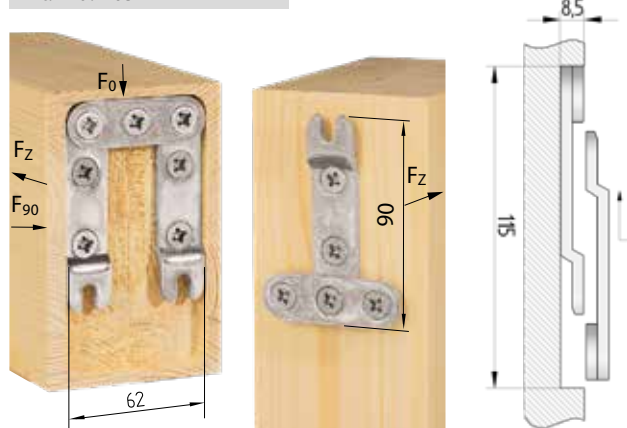

Mounting screws	6x40	6x60	Load capacity		
			zul F ₀	zul F ₉₀	zul F _Z
CS, VG	5	7	Slide-in direction	Right angle to slide-in direction	Traction
			4,49 kN	1,81 kN	
Recommended timber dimension			Size of rebate		
Width/Height: 80/135 mm			Width	Height	Depth
			62 mm	115 mm	8,5 mm

Acro Series 90

Acro 90/90 mm

Art.-No. K032

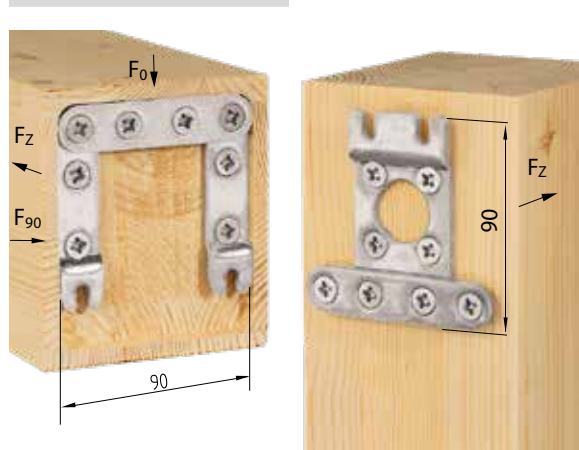

Mounting screws	6x40	6x60	Load capacity		
			zul F ₀	zul F ₉₀	zul F _Z
CS, VG	8	8	Slide-in direction	Right angle to slide-in direction	Traction
			5,40 kN	2,80 kN	
Recommended timber dimension			Size of rebate		
Width/Height: 115/135 mm			Width	Height	Depth
			90 mm	115 mm	8,5 mm

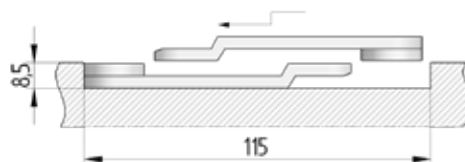

BASIS-System

Column mounting connectors

Benefits: Connector for direct mounting on solid surfaces, non-positive connection.

Installation: The BASIS column connectors consist of the BASIS 90/90, 62/62 and a galvanized steel base plate that is bolted to the ground. The counterpart is installed to the bottom of the post and sits inside a pocket that milled using a plunge router or CNC.

Suitable materials: Timber post to firm ground i.e. concrete slab, tiles, stone, wood etc.

Application: Connector to mount columns and posts.

Accessories: For 62/62: Routing Jig MULTI F62 | Art.-No. K504, TCT Slotter | Art.-No. Z066, CS-screw 5x60 mm | Art.-No. Z498
For 90/90: Routing Jig MULTI F90 | Art.-No. K505, TCT Slotter | Art.-No. Z066, CS-screw 6x60 mm | Art.-No. Z499



Basis 62/62 mm

Art.-No. K039

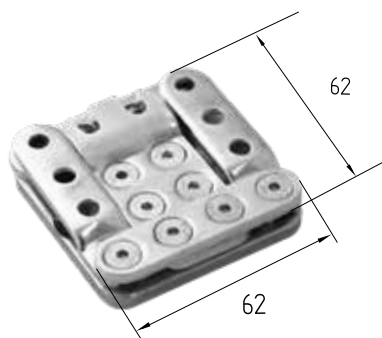

Mounting screws	5x60	M8	Load capacity		
			zul F ₀	zul F ₉₀	zul F _Z
CS, VG	8	2	Slide-in direction	Right angle to slide-in direction	Traction
			2,90 kN	2,47 kN	3,67 kN

Recommended timber dimension	Size of rebate		
	Width	Height	Depth
Width/Height: 78/95 mm	62 mm	82 mm	13 mm

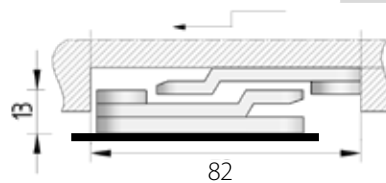

Basis 90/90 mm

Art.-No. K038

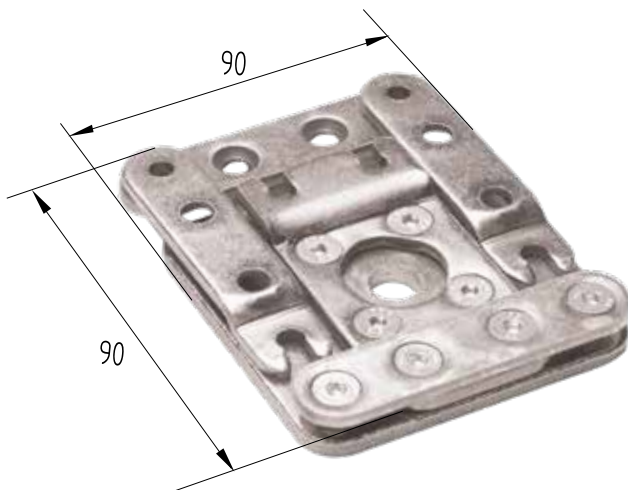

Mounting screws	5x60	M12	Load capacity		
			zul F ₀	zul F ₉₀	zul F _Z
CS, VG	8	1	Slide-in direction	Right angle to slide-in direction	Traction
			3,99 kN	2,07 kN	4,72 kN

Recommended timber dimension	Size of rebate		
	Width	Height	Depth
Width/Height: 115/135 mm	90 mm	115 mm	13 mm

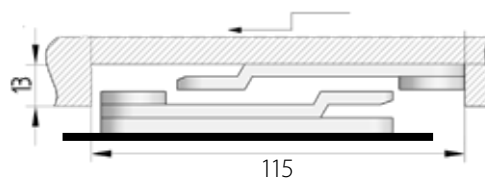

ACRO and BASIS installation



1) Route mortise with plunge router and routing jig.



2) Install ACRO connector brackets with screws



3) Assemble

The load value refers to the shear force in the insertion direction. Commercially available, CS screws (5x60 or 6x60 mm) in accordance with ÖNORM M 5027 and M8 CS screws or M12 screws must be used with the BASIS system. The test was carried out by Holzforschung Austria.

RICON® Stainless Steel

Universal connector made of A2 stainless steel up to 17,4 kN

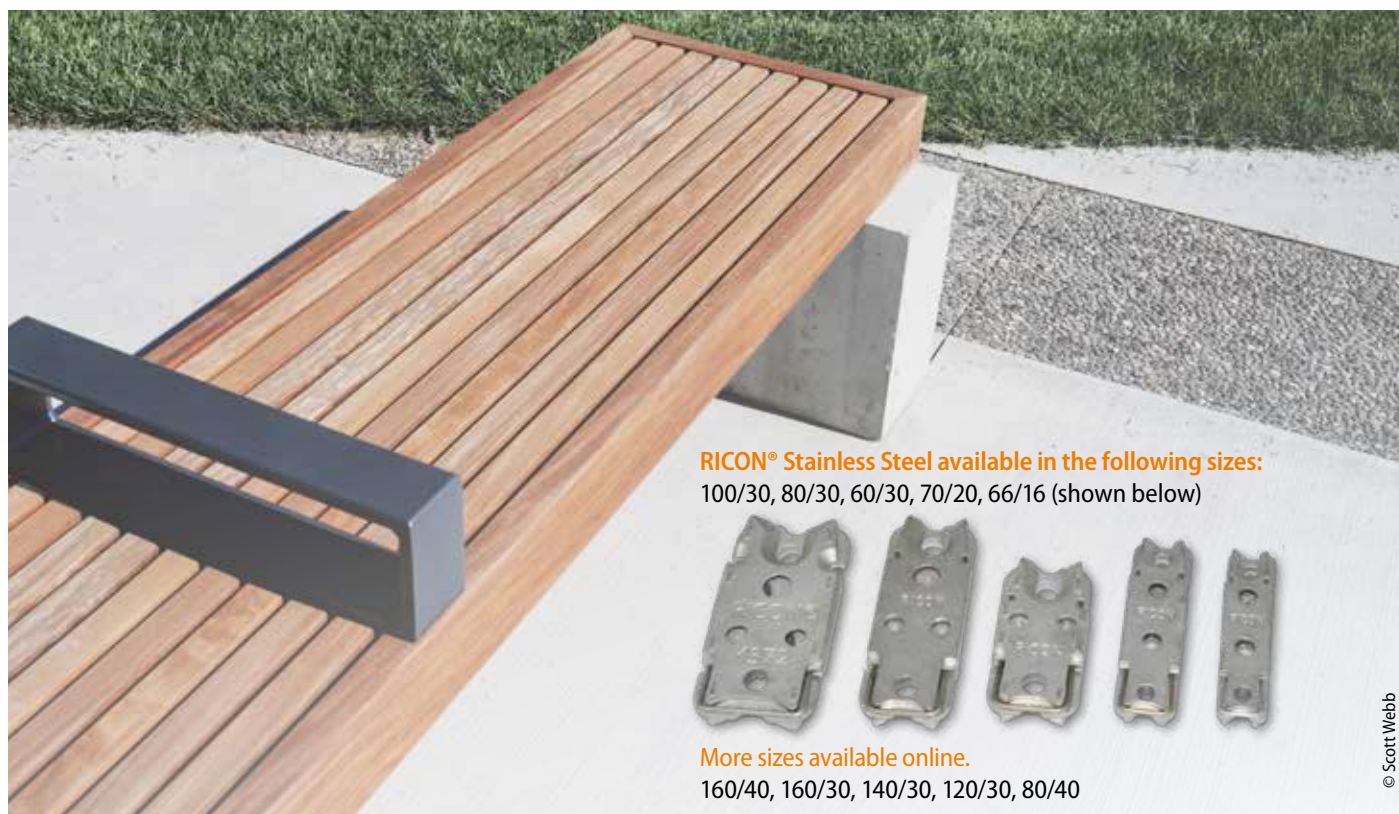

RICON® Stainless Steel available in the following sizes:
100/30, 80/30, 60/30, 70/20, 66/16 (shown below)

More sizes available online.
160/40, 160/30, 140/30, 120/30, 80/40

© Scott Webb

- Application:** Indoor and outdoor: furniture, balcony, deck, carport, playground and sports equipment, pergola, and light timber construction.
- Benefits:** Can be concealed or visible and used indoors and outdoors. Used with narrow timber widths starting from 20 mm upwards. High strength capacity up to 17,4 kN. Made of A2 stainless steel for usage classification 3.
- Installation:** Make route using plunge router and routing jig or with CNC. Install plates with $\varnothing = 5$ mm and $\varnothing = 8$ mm CS-screws. Can be used for single joint and double joint connection.
- Suitable materials:** All wood species including, such as oak, douglas fir, larch and impregnated woods, such as Accoya.
- Accessories:** 2 Flute Straight Router Bit | Art.-No. Z066, Routing template Multi F30 | Art.No. K501, K506..., Mounting set RICON® | Art.-No. K065.

RICON® 66/16 EA Stainless Steel ($F_{2,Rk}$ 4,8 kN*)

Art.-No. K267

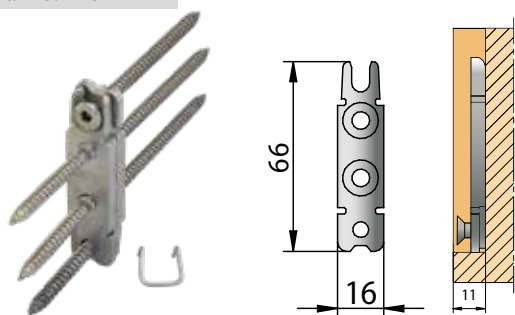

Connector	Type	Mounting screws		Charact. values [GL24h] NKL1*	
		Joist	Header	$F_{1,Rk}$ [kN]	$F_{2,Rk}$ [kN]
66/16	EA	3 x CS 5x80	3 x CS 5x50	3,5	4,8
1 locking clip: $F_{3,Rk} = 1,0$ kN			2 locking clips: $F_{3,Rk} = 2,0$ kN		

Minimum timber dimensions: 30 x 86 mm

*Interior Glulam

RICON® 70/20 EA Stainless Steel ($F_{2,Rk}$ 4,8 kN*)

Art.-No. K271

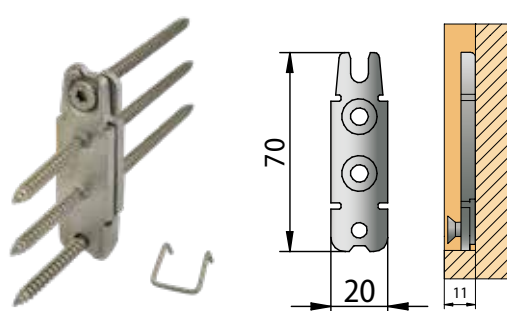

Connector	Type	Mounting screws		Charact. values [GL24h] NKL1*	
		Joist	Header	$F_{1,Rk}$ [kN]	$F_{2,Rk}$ [kN]
70/20	EA	3 x CS 5x80	3 x CS 5x50	3,5	4,8
1 locking clip: $F_{3,Rk} = 1,0$ kN			2 locking clips: $F_{3,Rk} = 2,0$ kN		

Minimum timber dimensions: 30 x 90 mm

*Interior Glulam

RICON® 60/30 EA Stainless Steel ($F_{2,Rk}$ 5,2 kN*)

Art.-No. K274

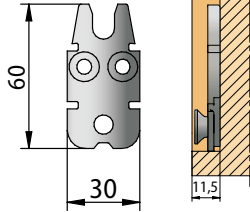

Connector	Type	Mounting screws		Charact. values [GL24h] NKL1*	
		Joist	Header	$F_{1,Rk}$ [kN]	$F_{2,Rk}$ [kN]
60/30	EA	3 x CS 10x120	3 x CS 10x80	4,4	5,2
1 locking clip: $F_{3,Rk} = 1,9$ kN			2 locking clips: $F_{3,Rk} = 3,8$ kN		

Minimum timber dimensions: 50 x 80 mm

*Interior Glulam

RICON® 80/30 EA Stainless Steel ($F_{2,Rk}$ 7,5 kN*)

Art.-No. K275

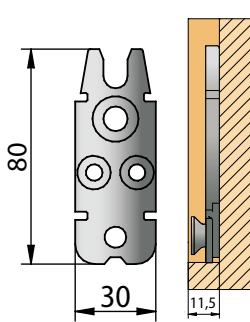

Connector	Type	Mounting screws		Charact. values [GL24h] NKL1*	
		Joist	Header	$F_{1,Rk}$ [kN]	$F_{2,Rk}$ [kN]
80/30	EA	2 x CS 8x80 2 x CS 5x80	2 x CS 8x50 2 x CS 5x50	4,4	7,5
1 locking clip: $F_{3,Rk} = 1,9$ kN			2 locking clips: $F_{3,Rk} = 3,8$ kN		

Minimum timber dimensions: 50 x 100 mm

*Interior Glulam

RICON® 100/30 EA Stainless Steel ($F_{2,Rk}$ 10,4 kN*)

Art.-No. K276

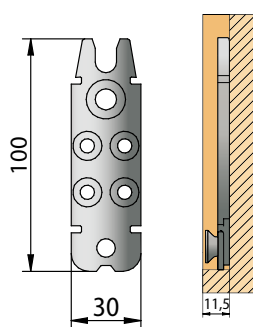

Connector	Type	Mounting screws		Charact. values [GL24h] NKL1*	
		Joist	Header	$F_{2,Kk,Rk}$ [kN]	$F_{45,Rk}$ [kN]
100/30	EA	2 x CS 8x80 2 x CS 5x80	2 x CS 8x50 4 x CS 5x50	4,4	10,4
1 locking clip: $F_{3,Rk} = 1,9$ kN			2 locking clips: $F_{3,Rk} = 3,8$ kN		

Minimum timber dimensions: 50 x 120 mm

*Interior Glulam

Other sizes can be found in the online store:

160/40, 160/30, 140/30, 120/30, 80/40

* Characteristic value $F_{2,Rk}$ in the direction of insertion only applies when using the original KNAPP®CS-Screw according to ETA 10/0189 (29.03.2019).**Installation**

1) Mill with routing jig.



2) Install with screws



3) Install the locking clip



4) Slide together



5) Secured connection with locking clip.

easy-con®

Tension element for table legs and stair treads



Art.-No. Z330 easy-con® M8-16-50



Art.-No. Z336 easy-con® M8-16-25

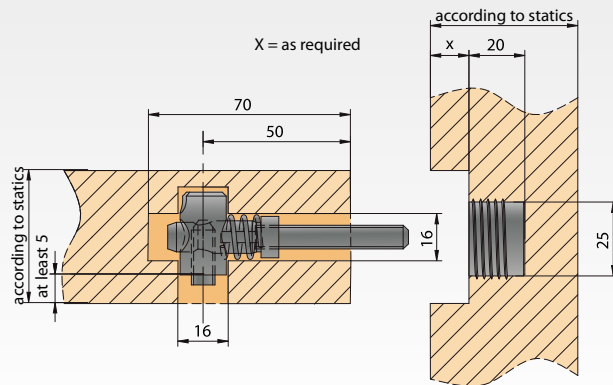

Application:	Table leg to table tops and stair tread to stringer connections.
Installation:	Pre-drill holes and insert connector pieces. Attach both components and tighten set screw.
Benefits:	Non-visible, demountable, self-tightening, strong.
Suitable materials:	All wood materials (solid and composite).
Traction strength:	3 kN

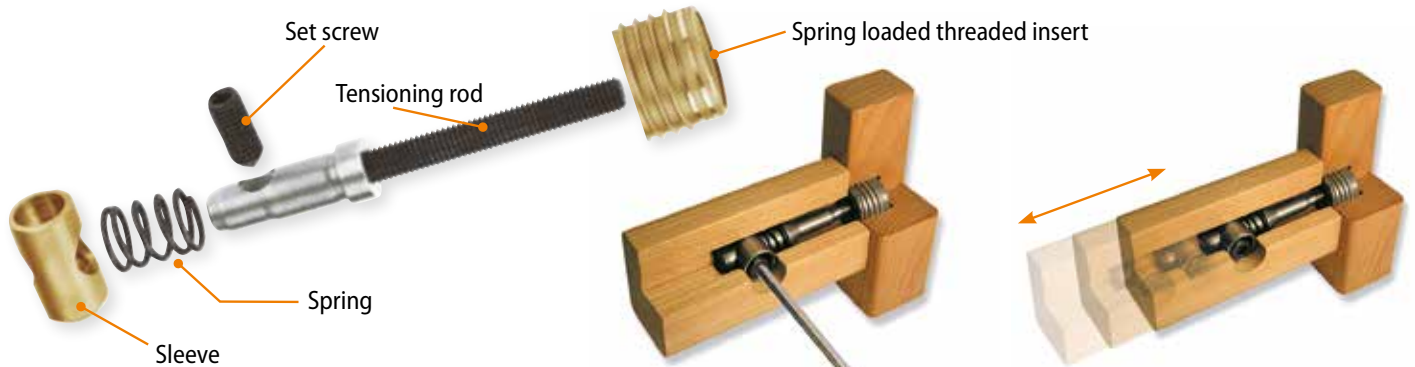

Example of table leg to table top connection

Stair installation: Tread can be mounted both on top or on the side of the stringer.



1) Screw-in threaded insert (SW 10)



2) Insert clamping elements in holes



3) Tighten elements (SW 4)



Stair steps attached and secured, connected with easy-con®

ZIPBOLT™ 90 KD

Joint connector for frames ≥ 22 mm

Art.-No. Z372

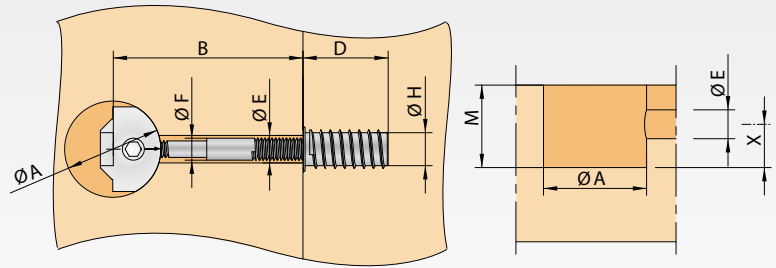

Load capacity up to 60 kg tension load (failure load approx. 100 kg)

Drilling depth M	X	Ø A	B	D	Ø H	Ø F	E
20 mm	9,5 mm	35 mm	60-65 mm	32 mm	12 mm	8 mm	9 mm

Application: Frame connector for beds and RTA furniture.

Benefits: Fast and easily installed by using a 5 mm hex bit SW5 in conjunction with cordless drill.

Installation: Pre-drill holes using plunge router or CNC. Insert connector parts into holes and assemble.

Suitable materials: For all solid wood and wood based panels.



ZIPBOLT™ 85

Joint connector for countertops ≥ 22 mm

Art.-No. Z358

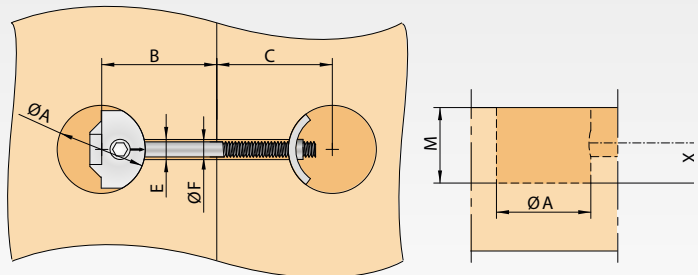

Load capacity up to 60 kg tension load (failure load approx. 100 kg)

Drilling depth M	Length	X	Ø A	B	C	Ø F	E
20 mm	85 mm	9,5 mm	35 mm	33-44 mm	33-44 mm	6 mm	8 mm

Application: Joint connector for worktops, countertops and panels.

Benefits: Fast and easily installed by using a 5 mm hex bit SW5 in conjunction with cordless drill.

Installation: Pre-drill holes using plunge router or CNC. Insert connector parts into holes and assemble.

Suitable materials: For all solid wood and wood based panels.



ZIPBOLT™ 120

Joint connector for countertops ≥ 22 mm

Art.-No. Z366

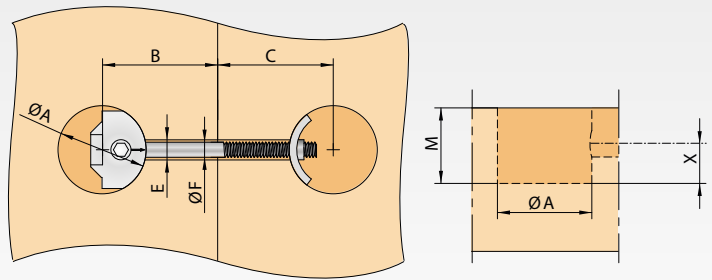

Load capacity up to 60 kg tension load (failure load approx. 100 kg)

Drilling depth M	Length	X	Ø A	B	C	Ø F	E
20 mm	120 mm	9,5 mm	35 mm	50-62 mm	50-62 mm	6 mm	8 mm

Application: Joint connector for worktops, countertops and panels.

Benefits: Fast and easily installed by using a 5 mm hex bit SW5 in conjunction with cordless drill.

Installation: Pre-drill holes using plunge router or CNC. Insert connector parts into holes and assemble.

Suitable materials: For all solid wood and wood based panels.



ZIPBOLT™ 170

Joint connector for countertops ≥ 22 mm

Art.-No. Z367

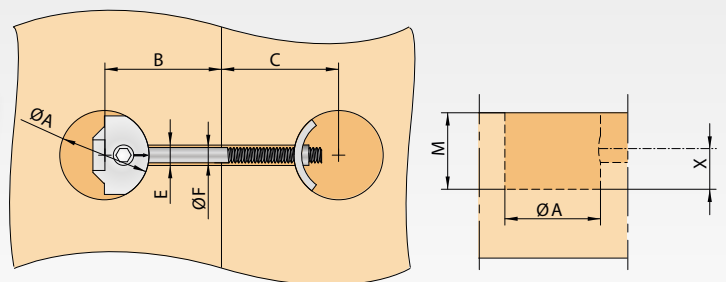

Load capacity up to 60 kg tension load (failure load approx. 100 kg)

Drilling depth M	Length	X	Ø A	B	C	Ø F	E
20 mm	170 mm	9,5 mm	35 mm	74-87 mm	74-87 mm	6 mm	8 mm

Application: Joint connector for worktops, countertops and panels.

Benefits: Fast and easily installed by using a 5 mm hex bit SW5 in conjunction with cordless drill.

Installation: Pre-drill holes using plunge router or CNC. Insert connector parts into holes and assemble.

Suitable materials: For all solid wood and wood based panels.

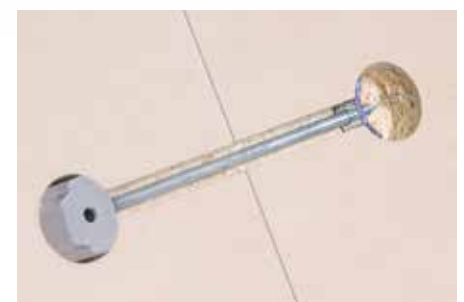

ZIPBOLT™ 100 MINI

Joint connector for countertops ≥ 16 mm

Art.-No. Z355



Load capacity up to 60 kg tension load
(failure load approx. 100 kg)

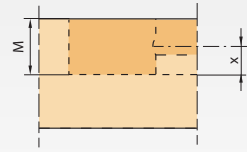
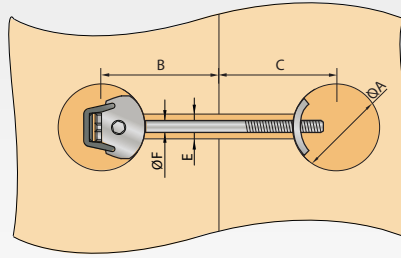

Drilling depth M	Length	X	Ø A	B	C	Ø F	E
12,5 mm	100 mm	5,5 mm	25 mm	42-49 mm	42-49 mm	6 mm	10 mm

Application: Countertop and panel connectors for straight butt joints.

Benefits: Fast and easily installed by using a 4 mm hex bit SW4 in conjunction with cordless drill.

Installation: Pre-drill holes using plunge router or CNC. Insert connector parts into holes and assemble.

Suitable materials: For all solid wood and wood based panels.



TREPPU

Levelling screw for stair treads

Art.-No. Z300

40 mm

Art.-No. Z310

70 mm

Art.-No. Z320

100 mm

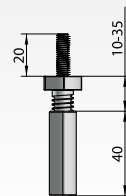

Treppo 40

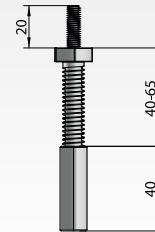

Treppo 70



Treppo 100

Tip: Moisten surface before gluing if wood is very dry.

Application: Stair tread assembly for new construction and renovations.

Benefits: Height-adjustable mounting screw for steps to compensate for height differences in switched concrete stages.

Installation: Concrete $\text{Ø} = 14$ mm and If wood $\text{Ø} = 6$ mm drilling. Bonding with KNAPP®-ADHESIVE PM + in the borehole.

Suitable materials: Wood stair treads attached to concrete, stone, and metal.

Accessories: KNAPP®-ADHESIVE PM+ | Art.-No. Z010
see page 31



1) Pre-drill holes



2) Glue and insert



3) Transfer bore holes



4) Glue and assemble

KNAPP®-ADHESIVE

Polyurethane adhesive - Heat resistant up to 120 °C (248 °F)



KNAPP®-ADHESIVE PM+

- | gap-filling for wide joints
- | low rise foaming
- | water resistance according to D4 DIN EN 204
- | free from curing agents

KNAPP®-ADHESIVE PU+

- | gap-filling for thin joints
- | for fine surfaces
- | water resistance according to D4 DIN EN 204
- | free from curing agents

TRIED-AND-TESTED
 | fast curing
 | solvent-free

	KNAPP®-ADHESIVE PM+	KNAPP®-ADHESIVE PU+
Article-No.	Art.-No. Z010	Art.-No. Z011
Application	Suitable for on-site work and rough surfaces.	Wide range from furniture to window manufacturing, suitable for fine surfaces.
Benefits	An easy to handle one-component polyurethane adhesive, gap-filling, water resistant, formaldehyde-free according to DIN EN204 - D4.	An easy to handle one-component polyurethane adhesive free from curing agents and formaldehyde-free, water resistant according to DIN EN2017 - D4.
Application instructions	Apply on one side, it will foam during the curing process. Skinning time is about 7 minutes, functional strength after 20 min, curing time at approx. 24 hours, working temperature minimum +7°, moisture content of wood 8 - 18 %, adhesive testing is recommended.	Apply on one side, it will foam during the curing process. Skinning time is about 10 minutes, functional strength after 20 min, curing time at approx. 24 hours, working temperature minimum +7°, moisture content of wood 8 - 18 %, adhesive testing is recommended.
Suitable materials	Wood and building materials, many plastics, stone, ceramic, metal and KNAPP®-Connectors, especially the TREPPO (2 or 3 cartridges are needed for 100 drillings).	Large range of wood materials, all types of plastic, stone, metal and all recommended KNAPP®-Connectors.
Mounting	General application instructions with the technical and safety data sheets is available to download.	



KNAPP®-ADHESIVE PM+ is recommended for fixing wooden stair-treads:

TREPPO



KNAPP®-ADHESIVE PU+ is recommended for:

CHAMP



KNAPP®-DOWEL



CLIPS



miniCLICK

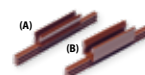



▶▶▶ Contact

+43 (0)74 74 / 799 10
info@knapp-connectors.com
+1 877-888-7773
info@KNAPPconnectors.com
knapp-connectors.com/contact



▶▶▶ Service

Need the right connector for your next project? Find your sales representative easily on our website:
knapp-connectors.com/contact



24/7
▶▶▶ online-store

Do you want to order around the clock? Our online store is open 24/7.*
knapp-connectors.com/online-store
* not available in Switzerland and America.



▶▶▶ Downloads

All brochures, data sheets, technical details are available for download on our website.
knapp-connectors.com/downloads



Concealed | Self-tightening | Demountable



01/2019 | KNAPP - Brochure Furniture and architectural millwork © The KNAPP logo is a registered trademark of the trademarkowner Knapp GmbH, A-3324 Euratsfeld.

The technical contents in this brochure are valid, until a (on our website for download) new brochure is available. This brochure is the exclusive property of Knapp GmbH. Duplication, reproduction or publication, including excerpts, only with the prior written permission of Knapp GmbH. All calculations given in this brochure are made in subject to any printing and typing errors and other mistakes. Technical drawings and calculations, especially those affecting the statics, on customer's own responsibility. Any calculations and drawings in this respect by the company Knapp GmbH are subject to proposals for the orientation and / or liability for the accuracy and therefore not free the customer to wear it even for a proper drawing and calculation by a professional concern. Picture credits are available and can be requested if required. All rights reserved. Copyright © 2019 by Knapp GmbH.



Knapp GmbH | Wassergasse 31 | A-3324 Euratsfeld | Tel.: +43 (0)7474 / 799 10
Fax: +43 (0)7474 / 799 10 99 | E-Mail: info@knapp-connectors.com

KNAPP[®]
connectors.com

www.knapp-connectors.com

Instagram knappconnectors

Facebook Knapp GmbH | @knappverbinder

Shopping cart icon 24/7 online-store