



NEW
PRODUCT

DUO 30

inox A5

Connecting Your Ideas ...

KNAPP[®]
connectors.com

DUO 30 inox A5

The inox A5 suspension hook connector

Fixing decorative elements indoors and outdoors.

The new DUO 30 inox A5 connects facades, cladding, furniture and building elements in outdoor areas quickly and securely.

It is designed to withstand strong corrosion (A5), extreme weathering and salt water. It is suitable for all wood materials or plastics, especially for interior fittings on yachts and ships.

The DUO 30 inox A5 connector set consists of two identical round shaped steel brackets that hook into each other in a dovetail-like manner, each of

which has three positioning and holding tips on the edge.

These press into the edge of the drill hole and place the connector in position, preventing it from slipping during screwing. The workpieces are ready for immediate tensile strength once fastened together. The DUO 30 inox A5 can either be fastened with PH screws, or glued.

Use of the optional DUO 30 locking clip prevents upward movement.

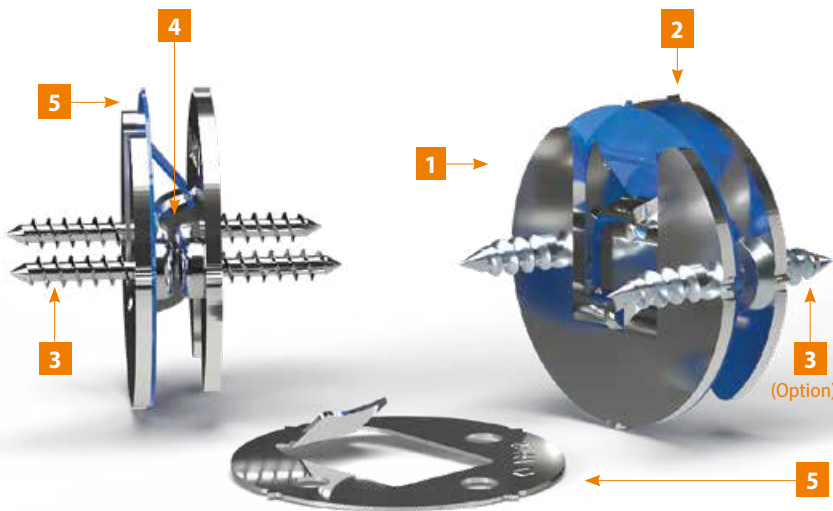

1 Round shaped steel bracket (A5)

2 Positioning and holding tips

3 PH screws 3x13 mm

4 Dovetail hook

5 Locking clip (A2)

■ The colour of the locking clip shown here is not representative of the actual product, which has been coloured to better illustrate the positioning of the clip.



PRODUCT



VIDEO

Benefits

- Precise and invisible
- Extremely weatherproof
- High degree of corrosion resistance (A5)
- Immediate tensile strength, demountable
- Easy to install - simple positioning and mechanical retention in the drill hole thanks to the holding tips
- Easy to fit together without additional tools

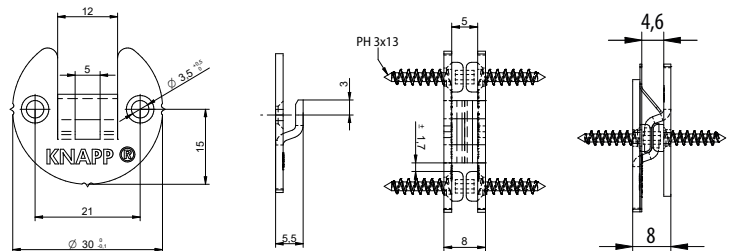

Applications: For façades, wall and ceiling cladding, panels, mouldings (ship and yacht building, sauna construction, outdoor), and constructions that require a high degree of weathering and corrosion resistance.

Advantages: Corrosion resistance (A5)

Material: All woods, wood-based materials and plastics

Processing: Screw in with PH screws
TCT Forstner drill bit 30 with adjustable brad point, bench drill or CNC

Installation: Position, press in and screw or glue together

Accessories: Stainless steel locking clip (A2) | Art.-No. K121, Centre punch DUO 30 | Art.-No. K071
PH screw stainless steel A2 3x13 mm | Art.-No. Z631
TCT Forstner drill bit 30 with adjustable brad point (Ø 30 mm) | Art.-No. Z070
Drilling template suitable for DUO 30 | Art.-No. K563

Application examples

Panelling



The new DUO 30 inox A5 variant meets the most demanding requirements for corrosion resistance. Ideal for connections in outdoor areas, it is also suitable for interior fittings and cladding.

Since the connector holds immediately after insertion by means of positioning and holding tips, it is easy to process precisely without additional tools. It even eases the strain of overhead work.



Components used in boat and yacht building must withstand extreme weather as well as highly saline sea air. In such an environment, connectors made of A5 inox are absolutely necessary.

It facilitates the installation of weatherproof and weather-resistant panels and boards, panels and claddings (e.g. wall and ceiling).

Decorative elements and outdoor furniture



DUO 30 of inox A5 resistant to heat and sea salt, is suitable for manufacturing and assembling interior and exterior cladding in saline environments.

At the same time, this applies to assembly in the factory and outdoors. It remains invisible, can even be dismantled and is therefore ideal for stable fastenings aesthetically stylish decorative elements and for outdoor furniture.

Installing DUO 30 inox A5



Drilling with template or according to mark



Mark counter part drilling position with centre punch



Install the locking clip to secure the assembly



Position the connector using the holding tips



Secure with PH screws



Assemble

Accessories

Locking clip

Art.-No. K121 Locking clip (A2)



Center punch DUO 30

Art.-No. K071 Center punch DUO 30



TCT Forstner drill bit Ø 30 mm

Art.-No. Z070 TCT Forstner drill bit Ø30 with adjustable brad point



Adjustable drilling template

Art.-No. K563 Drilling template suitable for HM-Drill Ø 30 mm
(For positioning and drilling DUO 30 inox A5)

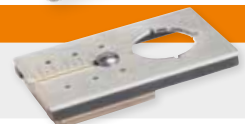

PH-screw und CS-screw

Art.-No. Z631 PH screw 3x13 mm



Get more information about corrosion-resistant connectors for indoor and outdoor use on our website: www.knapp-connectors.com/en :

Selftightening plastic dowel (polyacetal)

	KNAPP® DOWEL (3 dimensions)
	<ul style="list-style-type: none"> Weather resistant – connection for inside and outside application Robust – no opening of the joint due to shrinkage and swelling behavior, even when exposed to the environmental humidity changes Stable – highly loadable, especially in combination with KNAPP®-Glue PU+



Wooden connector made of stainless steel A2

	<p>RICON® stainless steel (15 sizes and 3 variants)</p> <ul style="list-style-type: none"> Minimum width of material from up to 20 mm Dissassembly and reassembly possible when needed Secure connection lockable via locking clip Connectors and screws made of inox Areas of application indoors and outdoors: Garden furniture, balcony, terrace roofing, carport, playground and sports equipment, pergola and other structures of service class 3
--	---

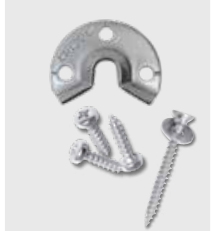

Hook connector made of stainless steel A2

<p>Art.-No. K117</p> 	<p>UNO 30 stainless steel</p> <ul style="list-style-type: none"> Concealed, self-tightening, lockable connector for Ø 30 mm holes Increased resistance to torsion of the floor Connectors, locking clip and screws made of inox For facades, panelling and cladding, for wall doublings and for hanging handrails
--	---



Biscuit connector of alu/zinc die-casting

<p>Art.-No. K614</p> 	<p>KOMBI</p>
<p>Art.-No. K615</p>	<ul style="list-style-type: none"> Concealed suspension connector, invisible from the outside Can be unhooked at any time KOMBI retaining bracket and screws made of inox For trade fair, shop and interior fittings, wall cladding, wooden panelling, façade panels and cladding, and decorative wall panels.

Hidden Deck Fastener - Installing decking boards perfectly

<p>Art.-No. K082</p> 	<p>Z-DECK</p> <ul style="list-style-type: none"> Recommended for planks and joints of 7 mm or more Robust - even suitable for decks and boat jetties Planks can be replaced quickly and individually Optimum wood protection due to self-cleaning joint design Joint formation more stable than visible connections (usually screwed from above) Increased resistance to twisting of the floorboards Connectors and screws made of inox
---	--



WEBSITE

Knapp GmbH | Wassergasse 31 | A-3324 Euratsfeld | Tel.: +43 (0)7474 / 799 10 | Fax: +43 (0)7474 / 799 10 99
 Knapp GmbH | Vertrieb Deutschland | Föhrenweg 1 | D-85591 Vaterstetten
 Tel.: +49 (0)8106 / 99 55 99 0 | Fax: +49 (0)8106 / 99 55 99 20 | E-Mail: info@knapp-verbinder.com

www.knapp-connectors.com/en



KNAPP®
 connectors.com